

# Customers Projects

Bridges

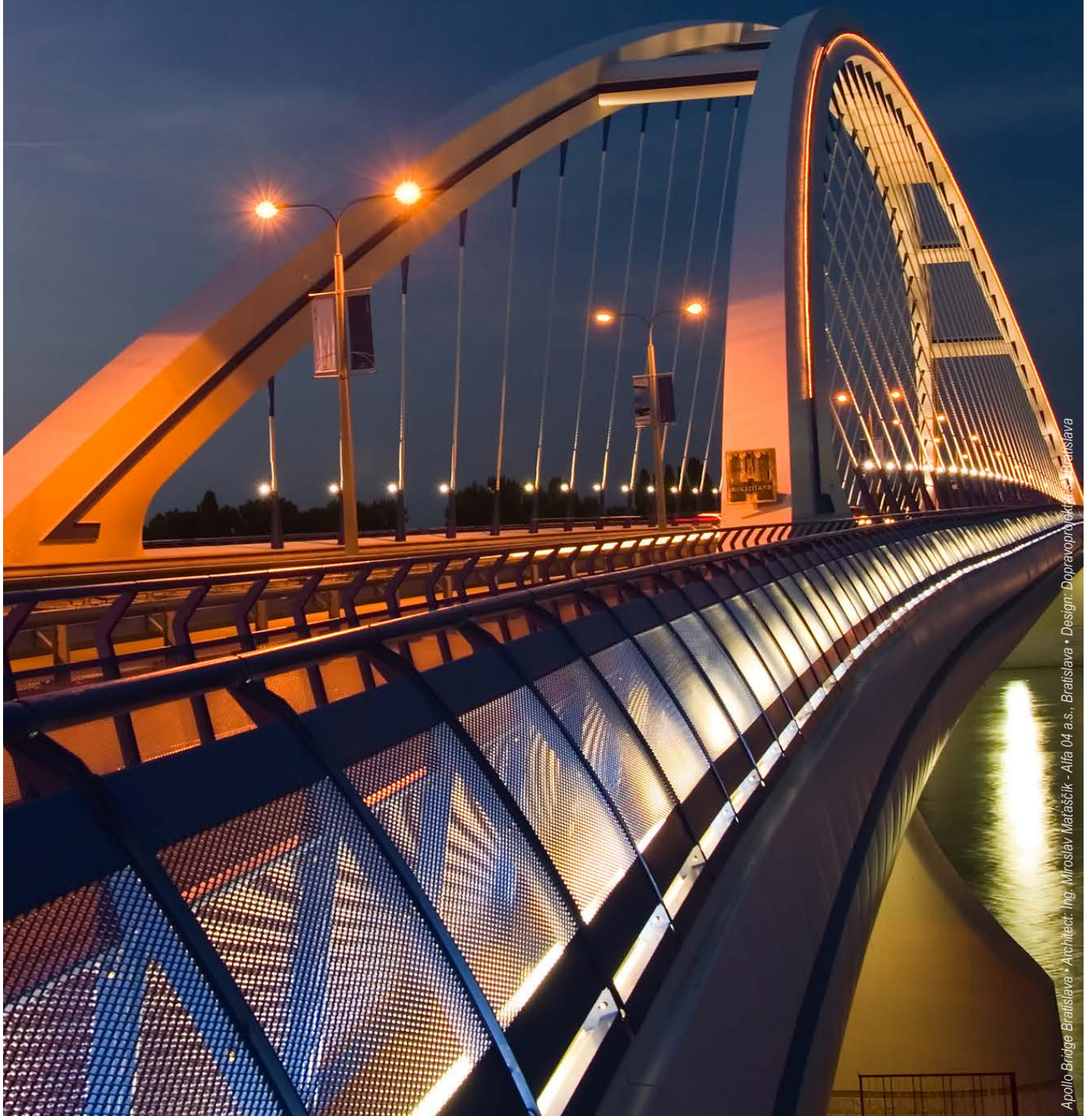

# “Vluchthaven” Footbridge

## Amsterdam, The Netherlands



Owner	Gemeente Amsterdam
Architect	Ney & Partners
General Contractor	Vandermade bv
Engineering Office	Ney & Partners
Location	Amsterdam, The Netherlands

### Structural analysis

Scia Engineer has been used to create an analytical model of the entire bridge out of 3D plates. There are mainly seven different types of elements that can be distinguished in the model:

1. The side, as 3D plates
2. The curved corner plates, as 3D plates
3. The light curved plates for the deck, as 3D plates
4. The U-shaped stiffeners above the abutments, as 2D plates
5. The flat stiffeners under the deck, as 2D plates
6. The concrete support structures as beams
7. The supports with the stiffnesses of the present foundation piles

Through the use of the 'import dxf/dwg' function, the 3D contour lines of the geometry have been uploaded. While tracing the imported lines and nodes, the curved plates were generated in the model.

Making use of a custom XML-tool we modeled the 98 load cases for the traffic loads.

The specific form of the stiffeners above the abutments could be modeled with the use of the 'cut-out' function. Also the flat stiffeners follow the geometry determined by the wave of the deck plate above.

Because it is a mobile bridge, along with the closed situation three open versions have also been modeled to calculate the effects of the wind on the structure during the opening and closing.

With the 'Productivity toolbox' the entire plate geometry has been exported in table form into the calculation note along with all the results of the linear calculations. The 'stability analysis' was used to estimate the buckling behaviour near the support on the complete 3D model.

To investigate the vibratory behaviour of the bridge, the permanent part of the bridge was analysed with the use of the 'Dynamics analysis' function, using the full 3D model.

### Concept

The design for the Vluchthaven footbridge provides for an object that stands out for its graciousness and oneness. In a departure from classical engineering, our concept was to limit the hierarchy of the elements by merging several functions together into one whole. The Vluchthaven bridge is an example of integral design: the deck, cross members, main beam and the finishing are one. The bridge is conceived as a single curved and cutout plate.

Inspired by the elegant movement of a heron's wing during flight, the plate is slightly torsed around its axis, representing the backbone of the bridge. As a result, the form of the bridge evolves: the cross-section at mid-span is concave while the opposite happens above the supports, with the cross-section convex. This way the necessary constructive height is achieved on supports. It gives the Vluchthaven bridge its wave shape, admittedly modest, but sufficient to provide a visual experience and rhythm.

The bridge's light wave shape, referring to the light waves on the IJ lake, is structurally optimally used, and is continued in the design of the railing. This consists of a series of vertical elements following the wave. The absence of horizontal lines in the railing, additionally accentuates the shape of the bridge deck. This gives the entire bridge a calm and moderate rhythm. LED lights are embedded into the railing.

The mobile part of the bridge has been designed integrally with the bridge. While closed it is hardly visible.

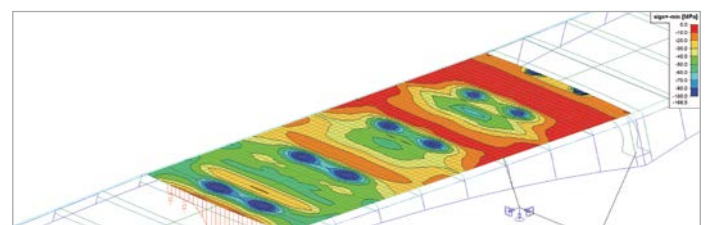
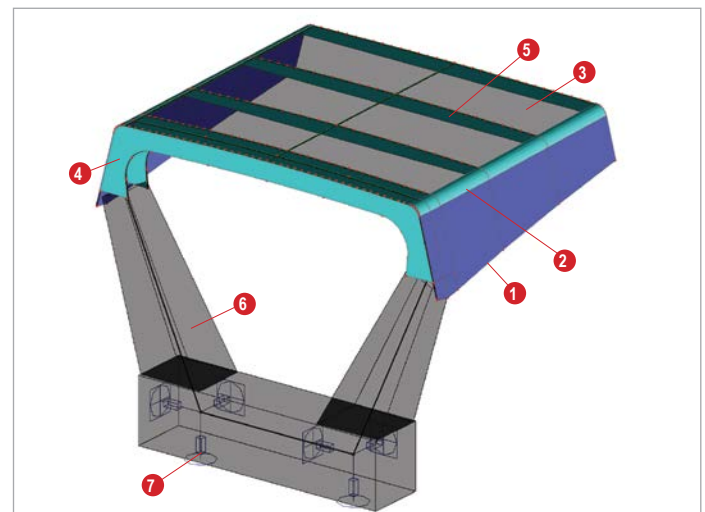
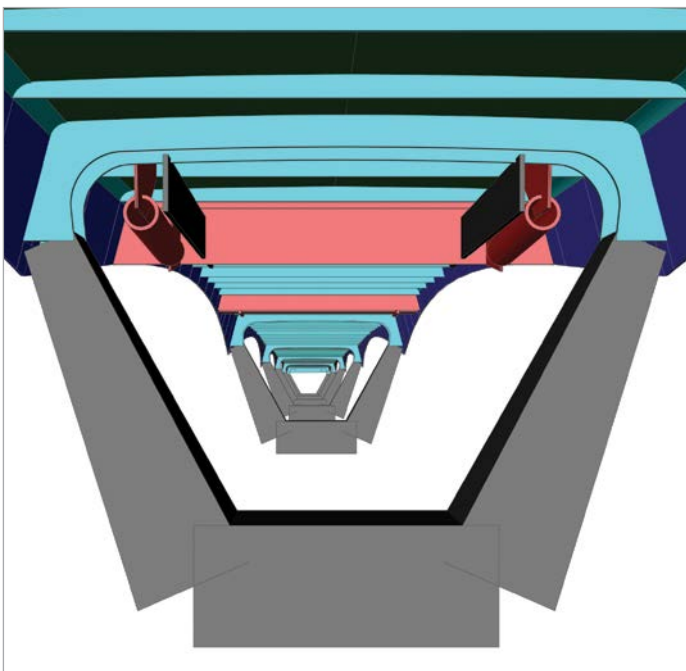

Owner	Gemeente Nijmegen
Architect	Ney Poulissen Architects and Engineers
General Contractor	BAM Civiel bv and Max Boegl
Engineering Office	BAM Infraconsult bv
Location	Nijmegen, The Netherlands

### Introduction

The city of Nijmegen is building a new bridge across the river Waal to improve the accessibility to the city and traffic flow. The bridge will be built at the historical location known as "De Oversteek" ("The Crossing"), where American soldiers crossed the river to secure the existing Waal bridge during Operation Market Garden. The existing Waal bridge, dating from 1936, was at the time of completion the biggest arch bridge in Europe with a span of 244 m.

The contract to design, build and maintain the new bridge crossing the River Waal at Nijmegen was awarded to a consortium after a design competition in 2009.

The bridge has the total length of 1,400 m. The southern approach bridge on the Nijmegen side lies in a curvature with the radius of 500 m. The main span, with the length of 285 m, consists of a single tied arch structure and crosses the river Waal in a straight line, while the northern approach bridge is in a horizontal curvature of 2,000 m.

### Design of the approach bridges

The approach bridges consist of a succession of concrete arches. The spans of these arches are 42.5 m. The thickness of the arches at the columns is just under 1.5 m and in the centre of the span 0.5 m. The void above the arches is filled with foam concrete to reduce the weight on the arches and covered with mixed aggregates and asphalt layers.

The total continuous length of the approach bridge at the north side equals 703 m, including the abutment at the Oosterhoutsedijk. The length at the south side equals 275 m. The concrete arches of the northern and southern approach bridges are rigidly connected to the bridge columns and have no expansion joints.

### Modelling with Scia Engineer

The approach bridges were modelled in Scia Engineer using a 2D beam model for the preliminary and final design stages.

Geometrical non-linear calculations were carried out with the 2D beam model. With this model the buckling shapes of the arches were investigated and the second order moments were calculated.

To keep the bridge stable during the construction stages, a prestressed tensioning system of bars and beams, spanning between two arch crests, was set in place to take over the thrust force from the arch, which came into action as the falsework was removed. A second 2D beam model was set up to determine the force distribution during the various construction stages.

For the detailed design stage, a 3D model has been created consisting of shells, beams and plates. The horizontal curvature of the bridge, the changing angle to every support axis and the varying width of the in plane curved arches has been taken into account. Also, the complex shapes of the columns and river pier have been modelled. The piles with different lengths and horizontal and vertical spring stiffnesses for every axis were also modelled in the model.

The loads and load combinations according to the NEN-EN codes were applied. These loads included dead loads, creep and shrinkage loads, traffic loads, temperature loads, wind loads, support settlements, accidental loads and earthquake loads.

With the 3D model the internal force distribution was determined in order to design the required reinforcement. Moreover, the pile design has been carried out using the results of the 3D model.

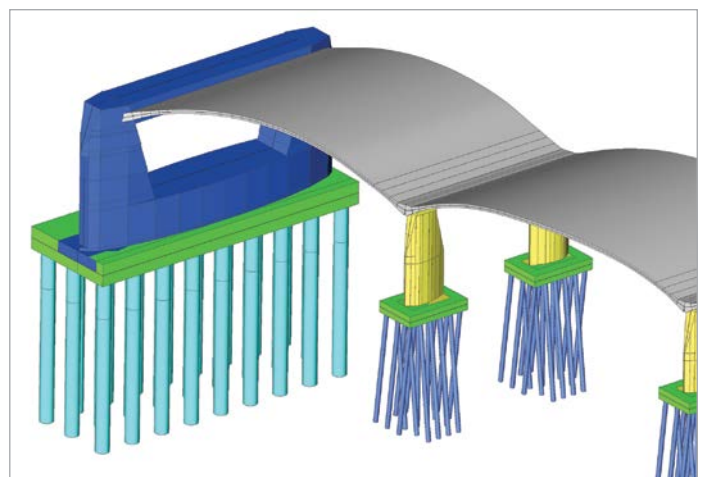
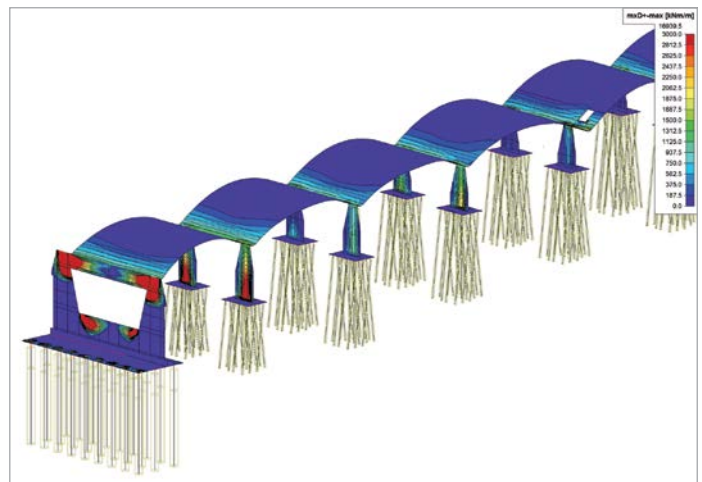

# “Scheepsdalebrug” Movable Road Bridge

## Brugge, Belgium



Owner	Waterwegen en Zeekanaal afd. Bovenschedde
Architect	Bureau Eggermont - Gent
General Contractor	THV Victor Buyck Steel Construction, Depret, Egemin
Engineering Office	Ingenieursbureau Stendess N.V.
Location	Brugge, Belgium

Second, there was a second order calculation needed for the check of the arms based on a stability calculation.

Third, the use of graphical sections with different material properties so as to model the exact weight of the bridge into the different states of the bridge.

Fourth, the calculation of eigenvalues / frequencies of the bridge in order to check if there were risks of vibration under wind loads.

Fifth, for the erection engineering the different construction stages had to be examined to determine the right camber of the bridge so that the arms could be welded correctly to the bridge deck on site.

### Introduction

The movable road bridge at Brugge is built to cross over the Brugge-Oostende channel. The new bridge replaces an old movable metallic bridge of the “Vierendeel” type.

The bridge has the width of 19 m and is a rolling bascule bridge with a movable pivot point. The pivot point has a radius that rolls over the concrete understructure. The bridge is powered by two jacks and the rolling movement of the bridge occurs according to the longitudinal axis of the bridge. The weight of the bridge (725 tonnes) is balanced by ballast that is positioned in two 15 m-high arms of the bridge. The span of the bridge is 40 m and the bridge has three traffic lanes with two separate lanes for pedestrians and cyclists.

The bridge deck is transported in one piece to the site together with the two arms. On the site the arms are welded to the bridge deck and the bridge is ballasted.

### Description of technical questions to be resolved with Scia Engineer

Scia Engineer was used both for the dimensioning of the bridge in the traffic situation and the erection engineering of the bridge.

The complete 3D model was formed with bars, even the orthotropic deck plate, divided into longitudinal and cross girders with an equivalent stiffness and adopted mass. Correct modellisation of the mass was very important because of the balancing of the bridge.

From the engineering point of view this project has several challenges.

First, there were the different states of the bridge to be studied.

The possibility of creating different states of the bridge in one model was a big advantage in terms of calculation of the bridge. With the automatic steel code check (EC) of Scia Engineer it was possible to check all members in all states in one calculation model. This gave an important gain in calculation / optimisation of the structure in the different states.

### Description of how our experience with Scia Engineer proved its completeness

- Dimensioning a 3D structure in different states.
- The possibility of using and combining the results of Scia Engineer in a flexible way.
- The use of graphical sections with different section properties.
- Stability calculation and second order calculations.
- Calculation of eigenvalues.

This project proves the great diversity of Scia Engineer in checking the structure and the use of materials.

Modules used:

- Base
- 3D frame
- Steel code check (EC)
- Stability
- Dynamics

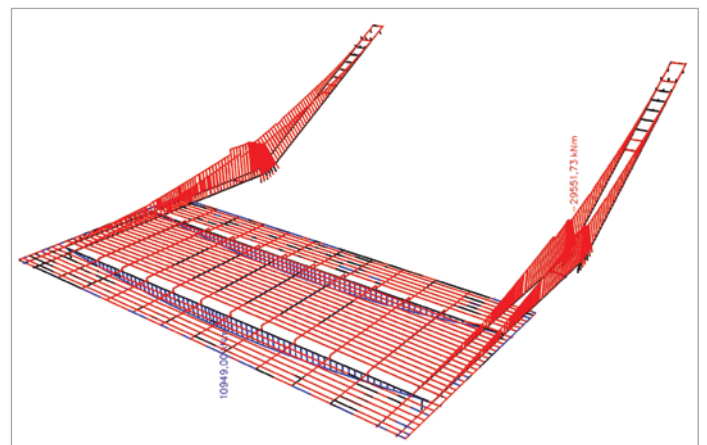
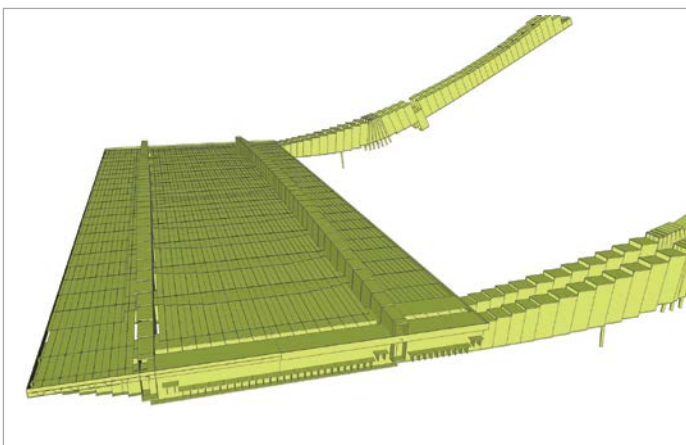
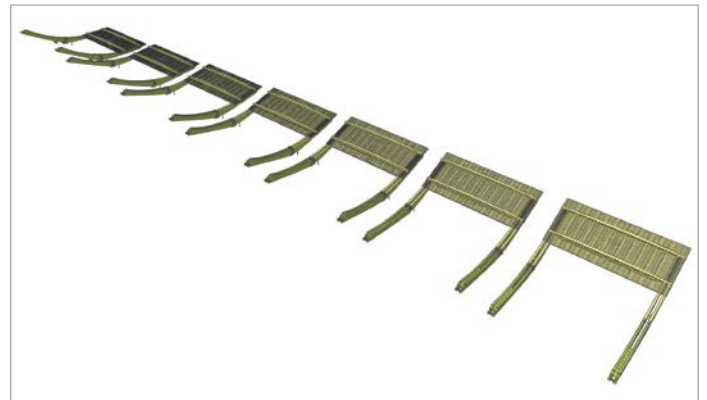

Owner	Infrabel
Architect	Infrabel I-I.53
General Contractor	West Construct: Besix, Aelterman
Engineering Office	Infrabel I-I.53
Location	Zwankendamme, Belgium

### Description of the bridge type and its characteristics

In order to respond to the expansion of the Port of Zeebrugge and the need for more capacity in container traffic, the number of tracks of the "Bundel Zwankendamme" has to be increased. Simultaneously, the safety will be increased by replacing the level crossing situated at Wulfsberge with a road bridge crossing the railway tracks.

The solution of a large single-span bridge was chosen: a bowstring bridge in steel with tie rods and prestressed concrete decks. The abutments are in concrete and founded on piles.

The characteristics of the bridge are:

- A single span of 87.98 m.
- Steel grade S355J2G3.
- The cross-sectional view.
- 2 lanes for vehicles, each 3.5 m wide.
- An emergency lane, 1 m wide.
- A cycling path, 3 m wide: two-way traffic, also intended for occasional pedestrians.
- A high safety barrier (type IVB) and safety kerb (type IVA) will be installed for road traffic safety.
- Four pot bearings will support the bridge.
- Each abutment is supported by 60 concrete screw piles with a 60 cm diameter: 48 are vertical and 12 at a 1/10th angle. All have the length of 18 m.
- The bridge is made of 560 tonnes of steel.

### The bridge concept

As there will be a set of railway tracks under the bridge, it is not possible to build intermediate pillars. They would restrict the options of the track layout and they would have a minimum distance to the railway tracks. In addition, they would need to be dimensioned to cope with the considerable accidental collision forces.

For the 88 m span the arch bridge is the best option from a financial point of view. The construction height (distance between the upper side of the road and the bottom of the main girder) is very small for this kind of span, only 85 cm. The bridge has to be able to carry extraordinary loads of 360 tonnes, hence 12 axles of 30 tonnes.

The choice was made to provide one mixed cycling path rather than two single paths + footpath because all the cycling routes are on the south side of the bridge. The north side contains nothing but industrial sites. Intense usage by pedestrians is not expected.

Finally, the bowstring bridge is to be welded and assembled in place with minimal interference with the railway traffic.

The bridge will be put in place during a weekend when railway traffic is interrupted, so with minimal disturbance.

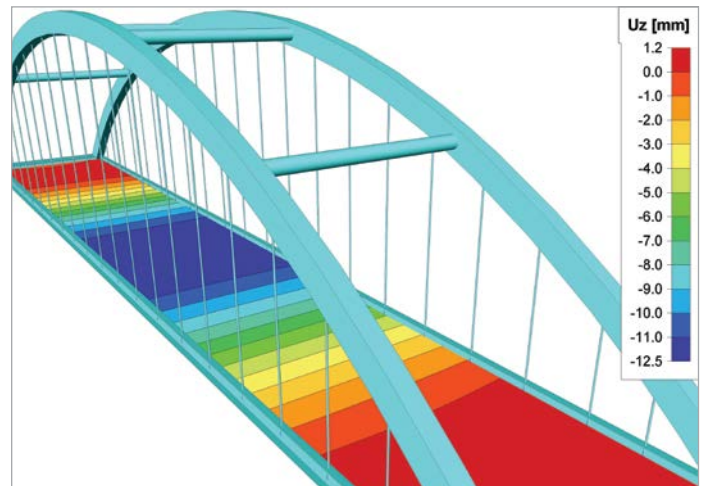

### Calculation techniques, technical specifics

3D modelling of the bridge was carried out in Scia Engineer 2011 to ensure the most accurate tension calculations.

A global model has been built to calculate the strength, stiffness and fatigue of the main steel structure and the prestressed concrete decks.

Geometry, material properties, preconditions and loads were all uploaded into the program.

A second-order check was also carried out in Scia Engineer.

Everything has been dimensioned and checked according to the Eurocodes.

This includes the following elements:

- Bearings
- Profiles
- Second-order check
- Prestressed decks
- Steel joints
- Several connections
- Abutment
- Girders between the arcs

### Used modules

- Steel code check (EC)
- Stability
- Physical non-linear conditions

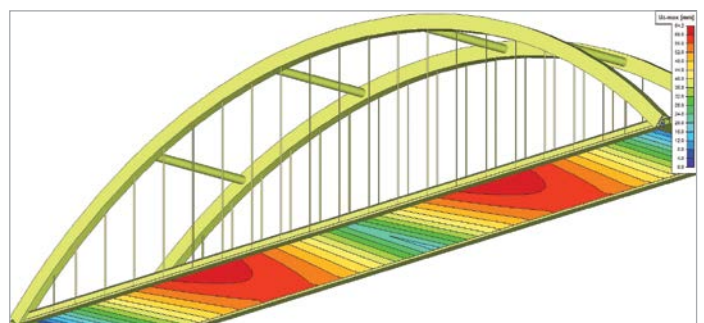
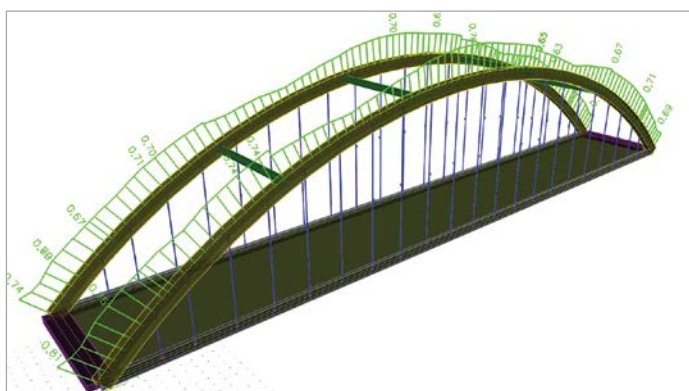
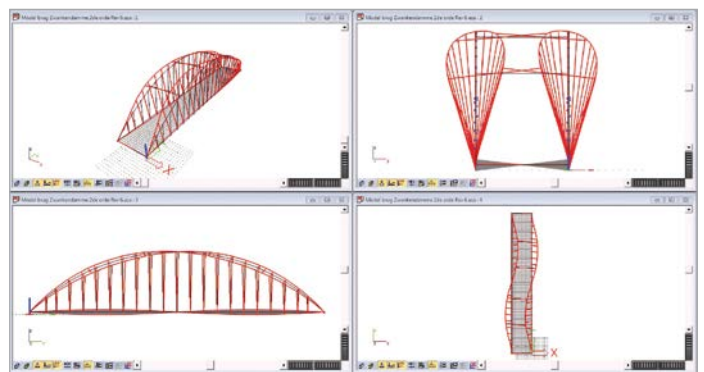

# Cyclist- and Pedestrian Bridge Metz, France



Owner	Ville de Metz
Architect	Brigit de Kosmi
General Contractor	Anmecco N.V.
Engineering Office	Terrell S.A.S. / Ingenieursbureau Stendess N.V.
Location	Metz, France

girder (referring to the dragon) and the elastic support of the cross girders gave a complex stability form that was used as input for the second order calculation.

Fourth, the evaluation of deformations during the construction phase. The bridge was lifted in one piece to its final position. The choice of the position of the lifting lugs was important in order to evaluate the deformation of the bridge during positioning.

## Description of how our experience with Scia Engineer proved its completeness

- Dimensioning a complex 3D structure in Scia Engineer by input of 2D dxf files.
- The possibility of using and combining the results of Scia Engineer in a flexible way.
- Stability calculation and second order calculations based on a complex stability form.
- Checking the dynamic behaviour of the structure by calculating the eigenvalues and the accelerations of the structure.

This project proves the great diversity of Scia Engineer in checking the structure.

## Modules used:

- Base
- 3D frame
- Dynamics
- Steel code check (EC)
- Stability

## Introduction

The cyclist- and pedestrian bridge in the centre of Metz crosses the river Seille in the contemporary Parc de la Seille. The bridge is officially known as the passerelle de Graouilly. The name refers to the mythical animal that is the symbol of Metz: the dragon.

The 64-metre-long bridge has a changing width from 8.7 m to 8.4 m and a changing height from 7.5 m to 6.8 m. The total weight of the bridge is 100 tonnes. The bridge has several cross girders in the form of a "U". These cross girders are connected by crossing rectangular diagonals. The net of diagonals is in equilibrium with a box-formed top girder that is anchored on 1 side of the bridge to limit the deformation of the bridge. The bridge is placed in one piece in its final place.

## Description of technical questions to be resolved with Scia Engineer

ESA-Prima Win was used both for the dimensioning of the bridge in the traffic situation and the erection engineering of the bridge.

The complex 3D structure was modelled in Scia Engineer with bars. The possibility of input of 2D dxf files in Scia Engineer was a big advantage so as to form the 3D structure in Scia Engineer exactly. Sufficient points were created in the bars to form the curved cross girders by linear bars.

From the engineering point of view this project has several challenges. First, there was the complex form of the bridge. The possibility of user-friendly input by Scia Engineer was a big advantage. The use of 2D dxf files made it possible to compose the 3D structure in Scia Engineer in a rapid manner.

Second, there was the dynamic analysis of the bridge. Because of the light and slender character of the bridge there was the need to calculate the eigenvalues / frequencies of the bridge in order to check if there were risks of vibration under pedestrian load or wind actions. The possibility of calculation of accelerations due to passing pedestrians in Scia Engineer was a big advantage.

Third, there was the second order calculation needed for the check of the box-formed top girder based on a stability calculation. The twisting form of the

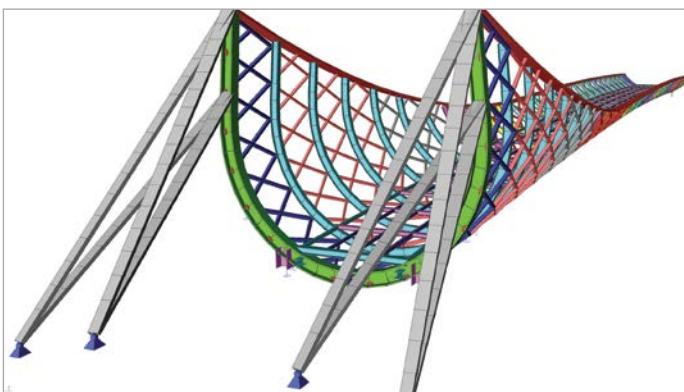
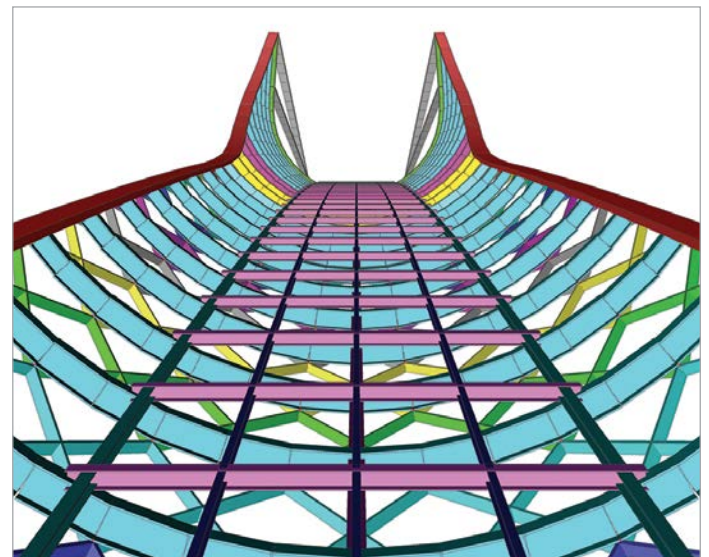

Owner	Provincie Zuid Holland
Architect	Hollandia B.V.
General Contractor	Van Hattum & Blankevoort, KWS Infa, Boskalis, Hollandia
Engineering Office	Ingenieursbureau Stendess N.V.
Location	Krimpenerwaard Gouda, The Netherlands

## Introduction

The movable road bridge at Gouda is built to cross over the Hollandsche IJssel. The bridge is a part of the project 'construction of the south-east ring road', aimed at achieving a better and easier road to Krimpenerwaard and decreasing the traffic in the centre of Gouda. The bridge is also called the 'Gouderakse brug'.

The bridge has the span of 30 m and is of the drawbridge type. The bridge is powered by two heavy jacks situated under the bridge deck. The bridge is balanced by ballast situated in the back of 2 peak arms, each supported by 1 tower. The bridge deck is hung up on the end of the arms by a tension bar. The arms have the total length of 40 m and are characterised by their peak and sharp forms.

The total weight of the bridge is 400 tonnes. That weight is balanced by 480-tonne ballast.

The bridge deck is built upside down. A special lifting procedure was foreseen to turn the 230-tonne heavy bridge deck afterwards.

## Description of technical questions to be resolved with Scia Engineer

Scia Engineer was used both for the dimensioning of the bridge in the traffic situation and the erection engineering of the bridge.

The complete 3D model was formed with bars, even the orthotropic deck plate, divided into longitudinal and cross girders with an equivalent stiffness and adopted mass. Correct modelling of the mass was very important because of the balancing of the bridge.

From the engineering point of view, this project has several challenges.

First, there were the different states of the bridge to be studied. The possibility of creating different states of the bridge in one model was a big advantage towards calculation of the bridge. With the automatic steel code check (EC) of Scia Engineer it was possible to check all members in all states in one calculation model. This gave an important gain in calculation / optimisation of the structure in the different states.

Third, the use of graphical sections with different material properties to model the exact weight of the bridge into the different states of the bridge. The input of complex forms for the arms and towers was possible thanks to the use of graphical sections.

Fourth, the calculation of eigenvalues / frequencies of the bridge in order to check if there were risks of vibration under wind loads.

Fifth, for the erection engineering the different construction stages had to be examined.

## Description of how our experience with Scia Engineer proved its completeness

- Dimensioning a 3D structure in different states.
- The possibility of using and combining the results of Scia Engineer in a flexible way.
- The use of graphical sections with different section properties.
- Stability calculation and second order calculations.
- Calculation of eigenvalues.

This project proves the great diversity of Scia Engineer in checking the structure and the use of materials.

Modules used:

- Base
- 3D frame
- Steel code check (EC)
- Stability
- Dynamics

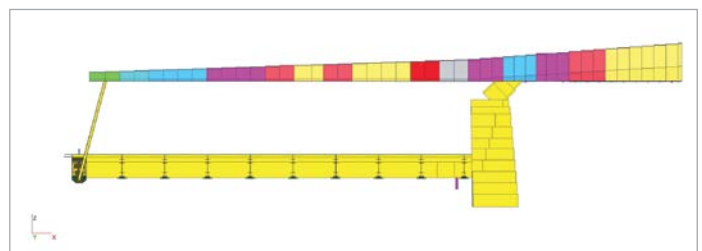

# Wooden Footbridge with a Cycling Track Across the River "Sava" - Bohinjska Bistrica, Slovenia



Owner	Dipl.-Ing. Matjaž Žabkar
Architect	Dans arhitects
General Contractor	ProTehno d.o.o.
Engineering Office	Loging d.o.o., Biro Udovč s.p.
Location	Bohinjska Bistrica, Slovenia

On each front wall there are two raised concrete seats for the timber beams of the main bearing structure. Both rebar and mesh reinforcement were used for the adequate reinforcement of cross-sections. The middle pillars are slightly different, being made as walls with two inclined arms. Each inclined arm has a seat for the main timber beam on top. The walls of the middle pillars are anchored to a massive concrete girder on two pilots, which are drilled 5 - 6 m deep in bedrock.

## Software and calculation model

Scia Engineer 2012 was chosen for the complete 3D-Modeling and for the calculation because there were three different structural materials in interaction. Some calculations were also "handmade", such as for the timber section design because of complex vertical and horizontal frequencies that had to be calculated to prevent uncomfortable vibrations.

The concrete design and reinforcement was carried out in cooperation with another engineering bureau with Nemetschek Allplan software. Some details for connections were also "handmade" and transferred into the computer design.

The footbridge is composed of three different structural materials. The main bearing structure and secondary bearing structure are designed as glue-laminated timber beams. Connecting members, anchoring seats and stability bracings are designed with structural steel. The complete supporting structure with foundations and pilots are designed as massive concrete structures.

## Architectural design

The architectural design is based on a smooth curved structure with a natural look to fit in a natural environment. Terrain at each end will be raised to prevent the flooding of the cycling track and pedestrian walkway. Both end foundation blocks will be partially filled with earth to form a new embankment raised to a new flood protection height. The main span is divided into three smaller spans with two middle support pillars. These pillars will be placed beyond the main river stream on dry river bed. The bridge structure is designed as a U-type channel with two large main beams connected with smaller cross beams at the bottom and longitudinal secondary beams for attaching walking boards.

## Design of the structure and technical data

### Timber bearing structure

Two main beams are used to bridge across all three spans. The cross-section dimensions of these beams are 24 x 160 cm. The middle span beams are curved beams because of the curved bridge design. Span sections are connected together with steel plates and a large number of bolts to assure a rigid connection. Hinge connections are used to attach the beams to concrete supports and steel sockets will be used because of the large height of the cross-sections, in order to gain stability and prevent overturning.

The main beams are connected with smaller cross-beam dimensions of 20 x 22 cm and are placed approximately every 5.0 m. The connections of these beams are rigid. This is achieved with the usage of steel plates and a large number of bolts in each connection. These beams also provide stability that counters overturning. Secondary beams with dimensions of 16 x 16 cm are then placed on top of the cross beams at an 83 - 84 cm distance to ensure the bearing of the final walking surface. The secondary beams are attached with hinge connections.

All the beams are made as glue-laminated beams with GI28h grade quality.

### Steel elements of the structure

Besides the steel plates for all the connections and anchoring seats, steel bracing diagonals were used to achieve the global stability of the structure. These diagonal bracings are placed in intersections of cross beams and main beams and are attached through steel plates on the socket connections of the cross beams. All the diagonals have a strain link to gain the correct tension of the elements. Some diagonal bracing elements must be anchored to concrete supports to assure the global stability of the structure.

### Concrete foundations and pillars

Both end foundation blocks are designed as concrete U-wall element blocks on strip foundations. The walls of the foundation blocks are 50 - 60 cm thick.

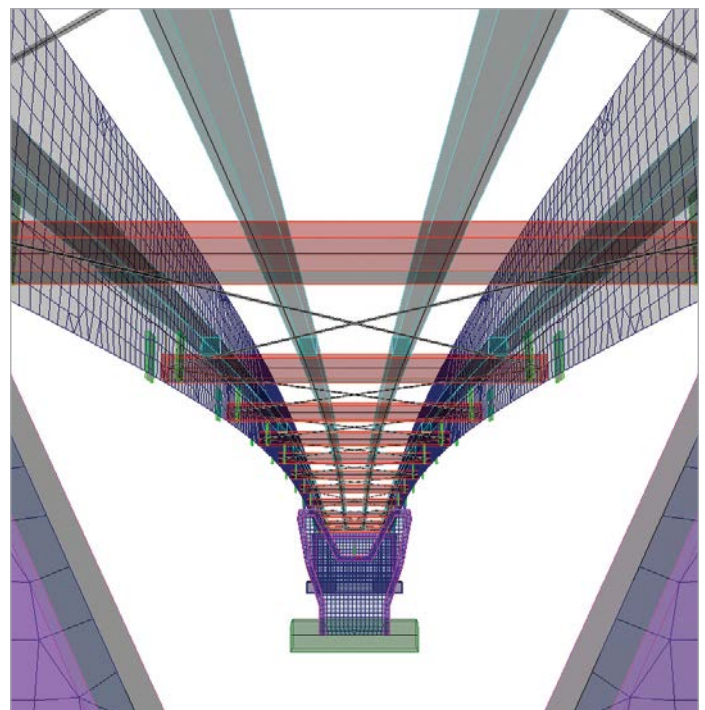
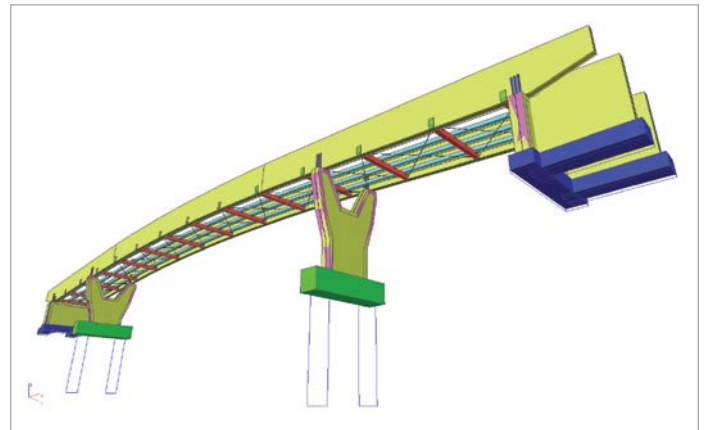



Owner	The Road and Motorway Directorate of the CR
Architect	Novák & Partner, s.r.o.
General Contractor	Metrostav a.s. Division 4
Engineering Office	Novák & Partner, s.r.o.
Location	Soběslav, Czech Republic

The Bridge over Koberný lake and a wildlife corridor at the 87,500 km point of the D3 motorway section running from Tábor to Veselí nad Lužnicí, with a total length of 552.8 m (58.4 + 4 x 109.0 + 58.4), is located in a non-built-up area, within the meliorative area of Koberný lake, about 15.4 m above the terrain surface. It is located approximately two kilometres south-east of the town of Planá nad Lužnicí, and about one and half kilometres north of the village of Košice. The valley which is traversed by the bridge is used for agricultural and breeding purposes.

The D 27.5/120 width configuration motorway bridge is set to a right-hand horizontal curve with the radius  $R = 1,750$  m and in vertical alignment is on a vertical curve with the radius  $R = 35,000$  m. Transversally, the roadway on the bridge is superelevated at 3.5 %.

The C 30/37 XF4 concrete grade pillars, with the cross-section of 8.0 x 2.5 m, are founded on 19 thirty-metre piles 1.2 m in diameter. The piles are keyed into R3 and R4 paragneiss to the depth of about 1.5 m. Under abutments and in the transition area, the ground is reinforced with gravel piles, allowing for the effect of the settlement of adjacent embankments with the average height of 12 m. According to calculations, the aggregate settlement of the adjacent embankments reaches up to 0.6 m. The abutments are founded on 10 deep piles. Water encountered during drilling for the piles was pumped to settling tanks behind the abutment to be liquidated in an environmentally friendly way.

Two pairs of casting carriages were used for the free-cantilever-method construction of the load-bearing structure of the box girder with the variable depth ranging from 2.69 m to 5.89 m. Casting of the girder proceeded symmetrically from 16-metre long balance arms. The stub was cast at two stages, on a scaffold provided by PIŽMO supports. Four temporary reinforced concrete supports with the cross-sections of 1.3 x 1.3 m were tied for stabilising the balanced cantilevers on each foundation. The stub in the assembling condition was with the foundation for each temporary support in relation to a pair of pre-stressing rods 47 mm in diameter. After the joints of the neighbouring stubs were made monolithic, all the temporary supports were deactivated.

Several mathematical models for apposite computational analysis of the structure during all the stages of the construction process were created in Scia Engineer. Calculations were realised with a global and local finite elements model using beam and (or) plate elements. Because of a great computational demand, or sometimes the poor relevancy of global models, some details of the structure and some phases of the construction have been modelled and calculated in separate models. Two global models were created. The first one - a 3D model, which consists of 1D members in proposed geometry - was made for clarification of the torque, for the assessment of inner forces from support settlement, the superimposed dead load and climatic effects, and for determination of the bearings load. The second one is a 2D flattened model which consists of 1D members. It was made for time dependent analysis. The model reflects the



rheology and loading history for the assessment of inner forces and deformations in specific time. For the shape modelling, the 1D member modeller was used with a Variable cross-section, General cross-section and Planar 2D members. Concrete designer modules were used for better time dependent behaviour understanding e.g. Post-tensioned tendons, a Prestress check and Time dependent analysis. The global analysis model is a 3D frame TDA model with beam elements respecting the proposed geometry. Cross-sections that are 1D member are defined as general cross-sections with a linear-variable connection. The piers are 1D members with a constant cross-section. The foundation details are calculated separately and in the global model are represented as an elastic support. The tendons are modelled using a Post-tensioned tendons module aid. Cantilever tendons in the upper plate of the deck and continuous tendons are applied as 1D member in real proposed geometry or in a flattened shape in a TDA model. The bearings are simulated as short 1D member with joints with specific material characteristics. In TDA a relevant displacement is released in a specific time. Temporary supports are rigidly connected to a balanced cantilever and in TDA they are also removed in specific time. The computation of inner forces is carried out with a standard linear calculation.

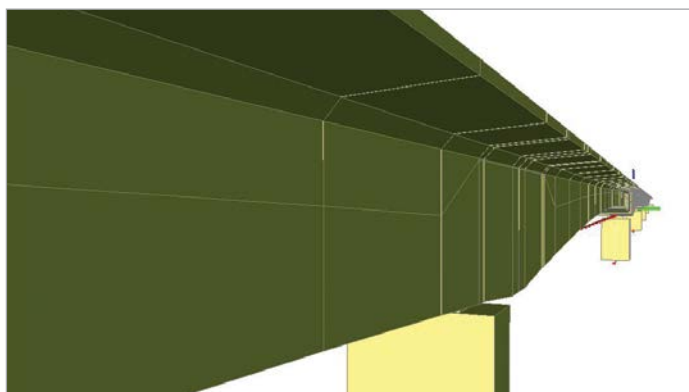
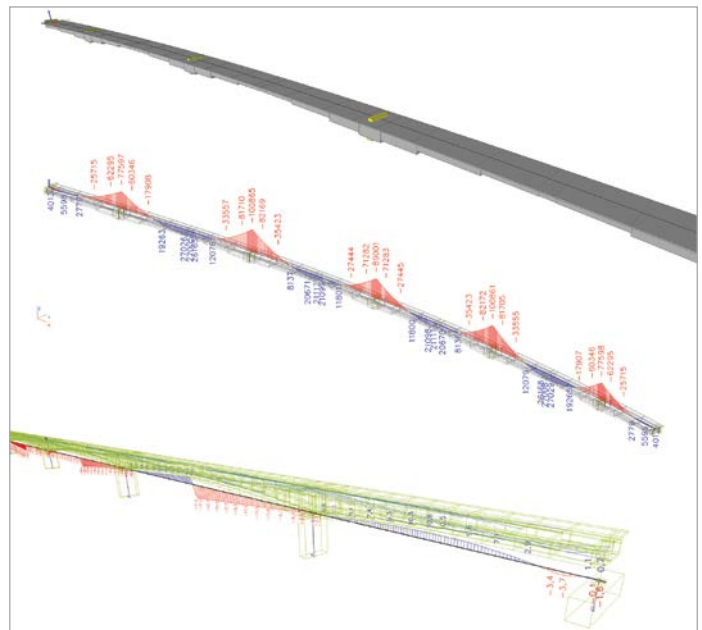

# “Ketelbrug” Movable Bridge

## Ketelmeer, The Netherlands



Owner	Rijkswaterstaat
General Contractor	BSB Staalbouw
Engineering Office	Movares Nederland
Location	Ketelmeer, The Netherlands

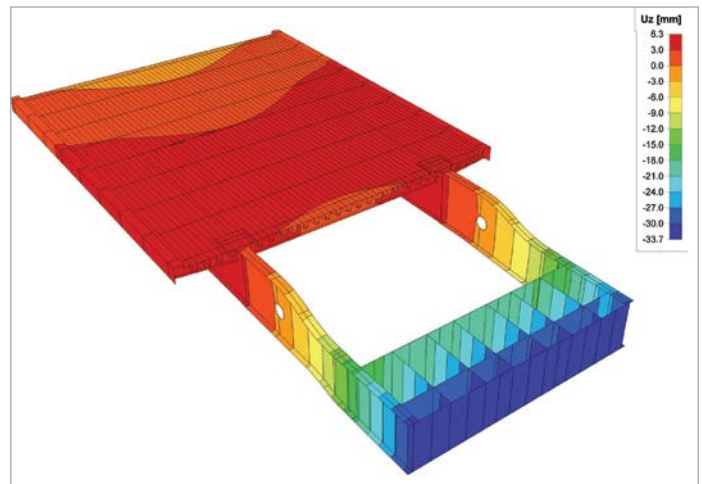
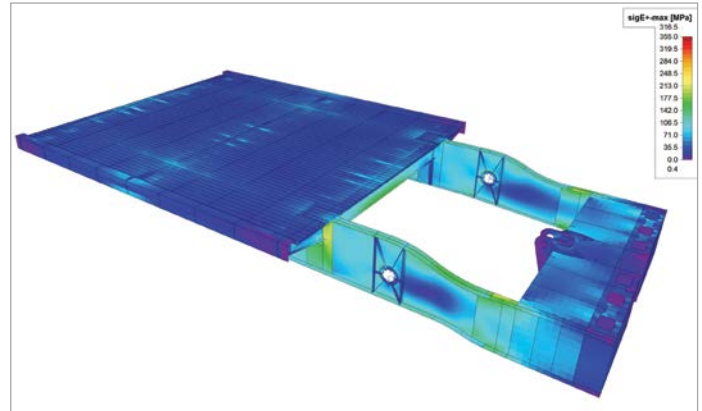

### Introduction to the Ketelbrug

The Ketelbrug is located at the A6 motorway crossing Ketelmeer between Lelystad and Urk in the Netherlands. The bridge has the total span of 800 m. A bascule bridge is incorporated.

The bridge consists of 2 carriageways, both on separate bridge decks, with 2 traffic lanes. On the east side there is also a connection for slow traffic. The height of the bridge is 13.1 m and it has a movable part on the south side.

The Ketelbrug is the property of Rijkswaterstaat (national road authority) and is one of the fourteen steel bridges which must be strengthened before 2018.

Since being put into service in 1970, the traffic has increased and the trucks become heavier. This increase is more than could have been provided for at that time. The heavier load has caused fatigue in the steel structure of the bridge. The renovation is intended to ensure the safety of the bridge deck.

The renovation of the Ketelbrug entails the replacement of the two moveable bridge decks and both accessory driving mechanisms, including the electrical systems. The renovation is in order to continue to guarantee smooth and safe flow on water and road. The goal of Rijkswaterstaat is to cause the least possible disruption for the traffic on the road and waterway. The replacement of the bridge deck must take place within a weekend.

### The project

The steel structural part of the project consists of creating a new design for the existing bridge deck. The new design of the bridge deck must be equal to the existing one, hence a minimum of modifications was required to the existing sub-structure. This requirement leads to a new design within the existing situation. The new design must be in accordance with the current regulations (EuroCode).

The deck of the Ketelbrug is an orthotropic steel deck where the troughs are welded between the girders. The cross girders span approximately 8 m between the two main beams. The main girders span approximately 23 m between the main bearing and the front supports.

### The use of Scia Engineer

The design of a bridge with a steel bridge deck is dominated by the fatigue assessment. For a good fatigue assessment, a very detailed model is needed. For this reason, the whole deck, including the counter weight, is modelled in Scia Engineer. The model is constructed entirely of plates. Locally, a very fine mesh is used to get detailed information.

To carry out a good fatigue assessment influence lines are needed. The influence lines are created with Scia Engineer by placing an axle load every 40 cm. This is done by using the function Traffic Loads (Lane Loads Manager). Furthermore, the result per load (axle load location) could be exported to a spreadsheet by using the detailed results in the mesh node. Finally, the fatigue assessment is realised.

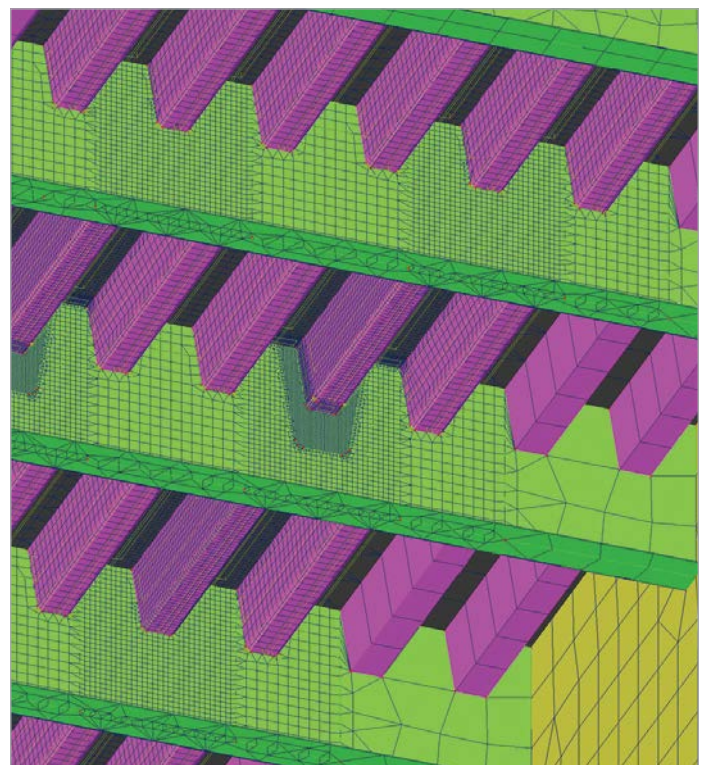

Owner	Rijkswaterstaat
Architect	Studio SK
General Contractor	Mercon Steel Structures
Engineering Office	Movares Nederland
Location	Weesp, The Netherlands

The Weesperbrug is located south-east of Amsterdam and dates back to 1937. The bridge has the total length of 144 m, with a main span of 96 m. The bridge crosses the Amsterdam-Rhine Canal. The Amsterdam-Rhine Canal is one of the main waterways in the Netherlands. The canal is an important connection between the port of Amsterdam and the Ruhr in Germany, making it one of the busiest inland canals in the world. Rijkswaterstaat, the administrator of the canal, put out a request for a tender for the major maintenance and strengthening of its steel arch bridges, to guarantee a residual life of 30 years. The contractor decided to replace the old bridge with a new one, instead of pursuing lengthy and risky maintenance and reinforcement activities. The new bridge will have an orthotropic steel deck, whereas the old bridge has a concrete deck. Therefore, the new bridge weighs considerably less than the old bridge, so the concrete foundation can be reused.

The Weesperbrug is one of eight bridges in the maintenance project which will be replaced by the contractor. The method of exchanging the old for the new bridge will minimise the nuisance to shipping on the Amsterdam-Rhine Canal and the environment. The new Weesperbrug will be constructed at the works of the contractor in Gorinchem, located at the river Merwede. This location has an advantage for transportation because the bridge can be transported across the river, over the North Sea and through the North Sea Canal to its final location on the Amsterdam-Rhine Canal.

#### The use of Scia Engineer

The calculations for the design of the new Weesperbrug are made using Scia Engineer. Furthermore, the temporary situations of removing the old bridge and placing the new one have been analysed.

Different types of models have been made for different types of verifications. At first a main model has been made. This model consists of the steel deck in 2D elements and all the other elements in 1D members.

This basic model is used for:

- Elaboration of forces in the main structure;
- Assessment of the main structure on the strength;
- Assessment of the main girders, arch and pendants on fatigue;
- Assessment of the (arch) stability;
- Assessment of dynamic (wind) effects on the pendants.

The arch stability is checked by finding the lowest buckling mode with corresponding n-value. These are used to calculate the critical buckling load and the buckling length, which were used in a buckling check in accordance with the Eurocode. For the dynamic wind effects on the pendants, a geometric nonlinear calculation was made for a realistic value of the stresses in the pendant at a certain amplitude.

The Weesperbrug has an orthotropic deck structure consisting of a steel deck plate with troughs as stiffeners. A sub-model consisting completely of fine-meshed 2D elements was integrated into the main model to analyse



the fatigue life. To carry out a good fatigue assessment, influence lines are needed. These are created with Scia Engineer by placing an axle load every 40 cm. This is realised by using the function Traffic Loads (Lane Loads Manager). Furthermore, the result per load (axle load location) could be exported to a spreadsheet by using the detailed results in the mesh node. Finally, the fatigue assessment is realised in the spreadsheet.

In another sub-model the most important connections are modelled using 2D elements with a fine mesh. In this model the strength of these connections is assessed. Again, the sub-model is integrated into the main model for realistic preconditions and forces. The connections checked by using this model are:

- Arch - Pendant
- Pendant - Main girder
- Arch spring - Main girder

Since there is only a couple of hours' time available to place the new bridge, it is placed in one piece from a pontoon on the canal. For some parts of the main girder this situation gives the largest stresses. In the main model the supports and loads are changed to verify all temporary situations.

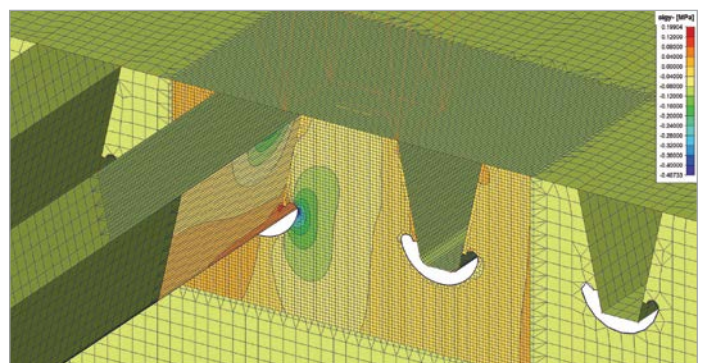
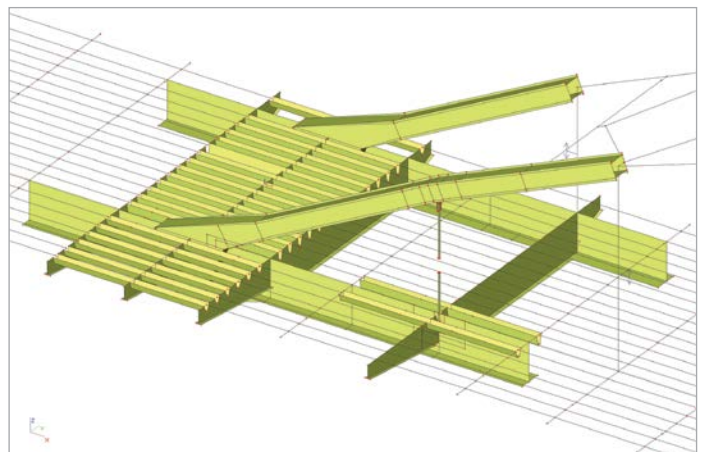

# New Troja Bridge over Vltava River Prague, Czech Republic

**NOVÁK&PARTNER**  
INŽENÝRSKÁ  
PROJEKTOVÁ  
KANCELÁŘ



Owner	Capital City Prague
Architect	Roman Koucky, Libor Kabrt
General Contractor	Metrostav a.s.
Engineering Office	Mott MacDonald a.s.; Excon a.s.; Novak&Partner Ltd.
Location	Prague, Czech Republic

to the arch. Each transversal precast beam is prestressed by two cables with nine strands. The concrete bridge deck is heavily prestressed. The transversal prestressing tendons are composed of four strands (15.7 mm) in flat ducts. The longitudinal prestressing is rather complex. Six cables with 37 strands are located in each composite tie. The slab is prestressed by a number of cables with 7 to 22 strands. The pedestrian stripes are located on the steel cantilevers, which will be attached to the edge stiffening concrete beam of the bridge deck.

The side span is a single span completely in situ cast prestressed concrete structure.

## Introduction and description of the bridge

The client, the City of Prague, announced the architectural competition in 2006. The winning project was submitted by the Mott MacDonald company together with the Roman Koucký architectural office. The construction process for this structure began in the summer of 2010. The general contractor for the bridge was Metrostav a.s., while the designer of the steel structure was Excon a.s. Novák & Partner Ltd. company was the designer of the incremental launching of the construction process and the temporary structures used for the construction process. Under the terms of the project supervision for the contractor, we also performed a lot of computational analysis of the structure with respect to all the construction stages.

The structure of the new Troja Bridge crosses the Vltava River in a northern part of Prague city centre. It connects the central part of the city with the city ring road. The bridge has two spans. The main span, 200.4 m in length, crosses the river, while there is a side span of 40.4 m in length. The bridge should open in 2013. The main span is crossed by a steel network arch, which is extremely flat (the rise/span ratio is 1/10), and by the suspended tied concrete deck. The bridge carries two tram tracks, four road lanes and two pedestrian lanes. The steel arch has a multiple box section at the midspan. The section splits into two legs close to the supports. The arch footings are fixed to the concrete deck and to the last massive in situ cast transversal beam. Due to the extreme load, the footings are filled with self-compacting concrete. The main span concrete deck is composed of a thin in situ cast slab, with a typical thickness of 280 mm. The deck is stiffened by precast prestressed transversal beams, which are only 500 mm wide and almost 30 m long, with a weight of 50 tonnes. They are suspended by tied network hangers. In the longitudinal direction, the deck is only stiffened by two arch ties with a composite cross section. The inclined hangers are in the diameter range of 76-105 mm. They have a pin and fork connection at the ends to the tie and

## Construction stage analysis and global supervision analysis

For the understanding of the response of the structure during the construction process several mathematical models were compiled. The simplest 2D beam model, where all the structure parts were modelled by the beam elements, was primarily used for TDA module analysis of the construction process, taking into account the effect of creep and shrinkage. The other models were rather more complex. In the case of the main 3D model, it was mainly planar 2D elements that were used; only for hangers and the temporary truss beam elements were used. For this model, 11,569 planar elements, 4,719 beam elements with 107 cross sections, 19,089 nodes, 7 materials and 107 load cases were defined.

This model was used for the global static, dynamic, non-linear (geometric and material non-linearity) and non-linear stability analysis. The model served also as the basis for the detailed design of the structure's aerodynamic stability. In the calculations of geometric nonlinearity, a solution was considered according to the theory of the second order. The nonlinear solution of suspension elements with an axial tensile force was made with respect to the tension stiffening theory. All the results were compared with simplified calculations on models for which exact analytical solutions are known. Bridge hangers were modelled as nonlinear beam elements with sag able to only transmit tensile axial forces. The main 3D mathematical model of the bridge structure was also used for the analysis of the dynamic effects of moving loads.

